

IV SERIES

solar way ,shining life

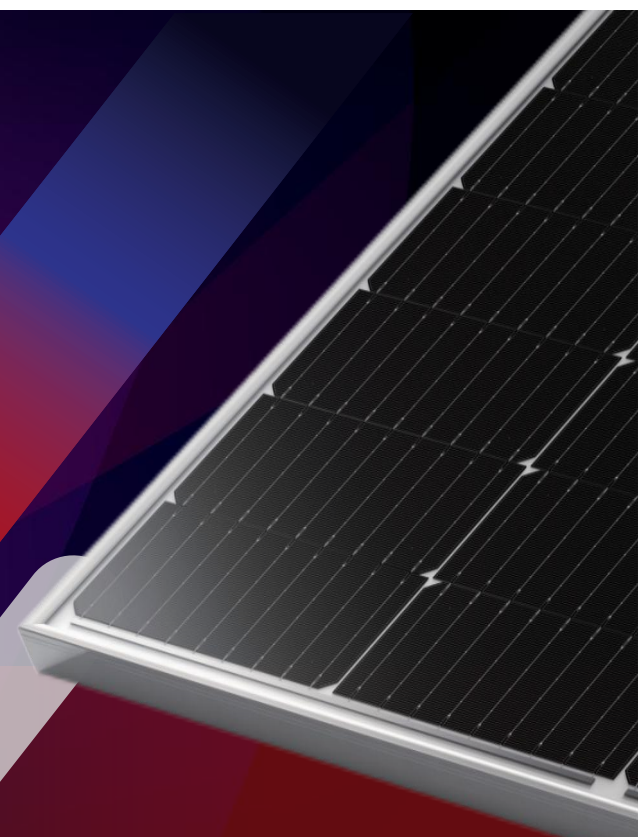





NB-60~68w-MS



● IV SERIES

Nabai redefined the high-efficiency module series by integrating 182mm*182mm silicon wafers with multi-busbar and One-fifths-cut cell technologies. Nabai panel combined creative technology effectively and extremely improved the module efficiency and power output.

● KEY FEATURES

-  Less mismatch to get more power
-  Less power loss by minimizing the shading impact
-  Competitive low light performance
-  3 times EL test to ensure best quality
-  Ideal choice for utility and commercial scale projects by reduced BoS and improved ROI
-  Outstanding reliability proven by PVEL for stringent environment condition:
 - Sand, acid, salt and hail stones
 - 2400 Pa wind load and 5400 Pa snow load
 - Anti-PID

● QUALITY SYSTEM

ISO9001 / ISO14001 / ISO45001

● PRODUCT CERTIFICATION



● INSURANCE



● WARRANTY

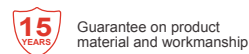
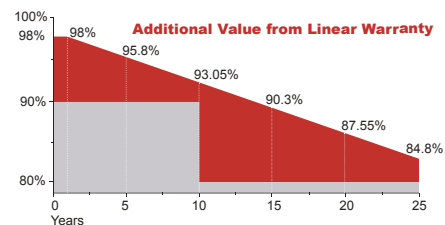

Electrical Characteristics

Module Type	NB-60-MS	NB-65-MS	NB-68-MS
	STC	STC	STC
Maximum Power at STC (Pmp)	60	65	68
Open Circuit Voltage (Voc)	18.9	19.1	19.3
Short Circuit Current (Isc)	3.17	3.40	3.52
Maximum Power Voltage (Vmp)	23.06	23.30	23.50
Maximum Power Current (Imp)	3.33	3.57	3.70
Module Efficiency at STC(η m)	16.13	17.47	18.28
Power Tolerance	(± 3%)		
Maximum System Voltage	600V DC		
Maximum Series Fuse Rating	10A		

STC: Irradiance 1000 W/m², module temperature 25°C, AM=1.5
 Power measurement tolerance: +/-3%

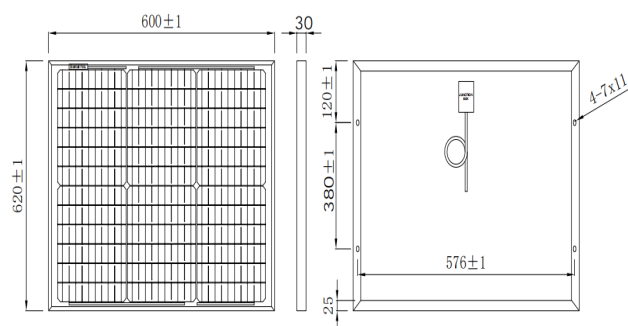

Temperature Characteristics

Pmax Temperature Coefficient	-0.34 %/°C
Voc Temperature Coefficient	-0.26 %/°C
Isc Temperature Coefficient	+0.05 %/°C
Operating Temperature	-40 ~ +85 °C
Nominal Operating Cell Temperature(NOCT)	45±2 °C

Mechanical Specifications

External Dimensions	620*600*30mm
Weight	5.2kg
Solar Cells	One-fifths-cut M10 Mono (36pcs)
Front Glass	3.2mm AR coating tempered glass, low iron
Frame	Anodized aluminium alloy
Junction Box	IP68, 3 diodes
Output Cables	2.5mm ² , 600mm(+)/600mm(-) or Customized Length with MC4 plug
Mechanical Load	Front side 5400Pa/ Rear side 2400Pa

I-V Curve

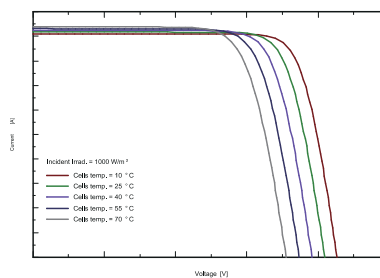
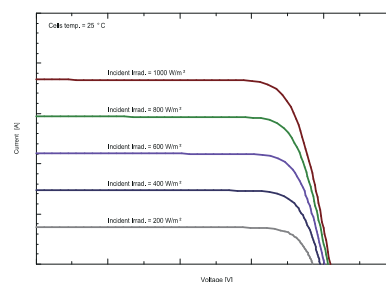

Packing Configuration

	620*600*30mm
Container	
Pieces per Carton	
PCS/container	
or Customized	